

SPECIFICATION

Axis	Z-Horizontal	-
Table size	60*60	[mm]
Travel Range	± 3	[mm]
Mechanical Type	Micrometer Head	-
Resolution	0.01	[mm]
Guide Mechanism	Cross Roller Guide	-
Parallelism	0.05	[mm]
Perpendicularity	0.01	[mm]
Materials / Finish	Aluminium / Black Ano	-
Load Capacity	3	[kgf]
Product Weight	0.3	[kg]

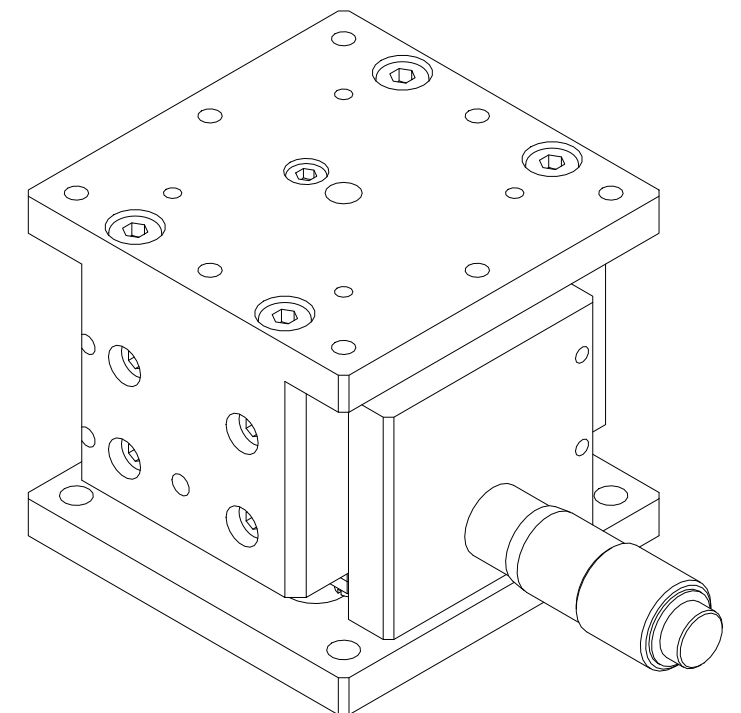
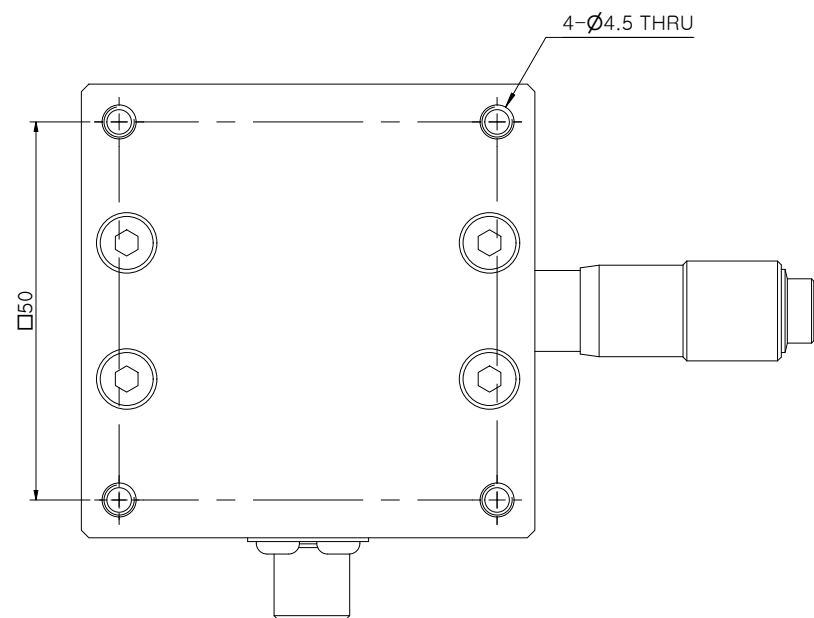
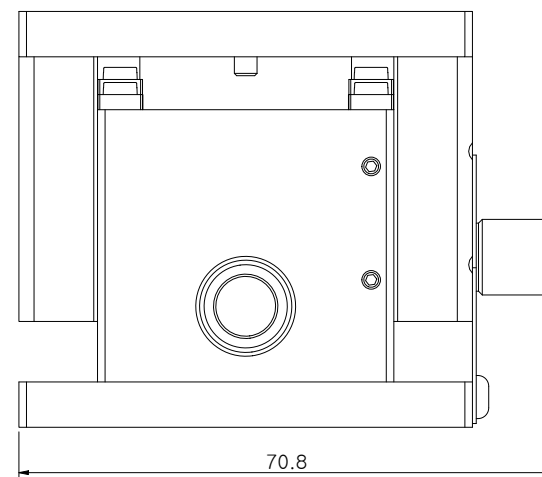
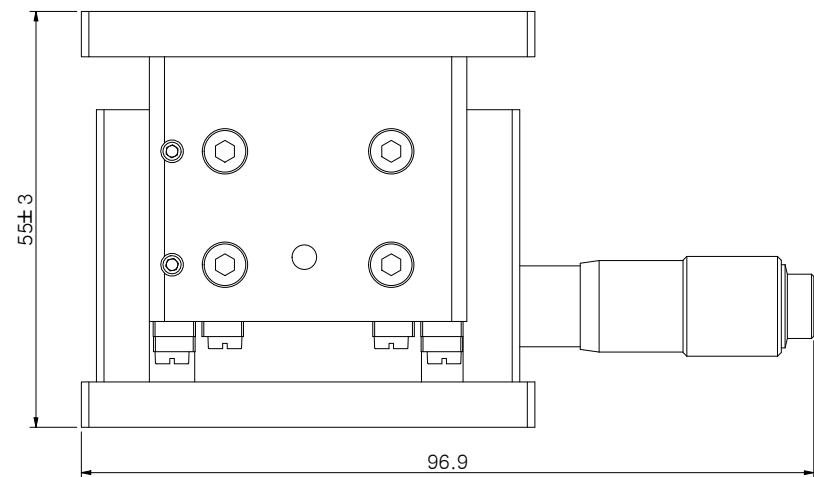
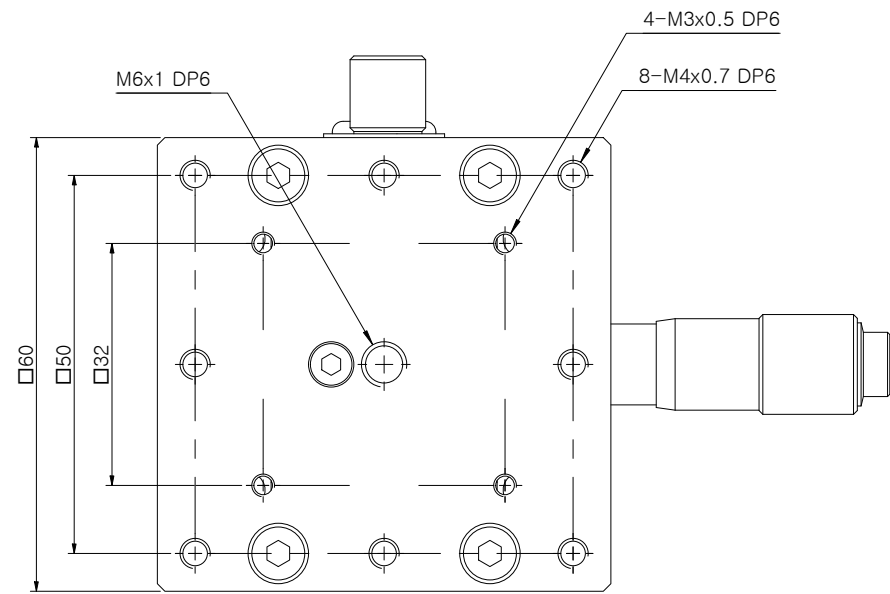

UNIT	MM	 JAEWON JAEWON.CO.,LTD.	TITLE	H-60-AMC
				