

SPECIFICATION

Axis	X	-
Table size	60*60	[mm]
Travel Range	± 6.5	[mm]
Mechanical Type	Micrometer Head	-
Resolution	0.01	[mm]
Guide Mechanism	Cross Roller Guide	-
Parallelism	0.03	[mm]
Running Parallelism	0.02	[mm]
Straightness	0.008	[mm]
Materials / Finish	Aluminium / Black Ano	-
Load Capacity	5	[kgf]
Product Weight	0.3	[kg]

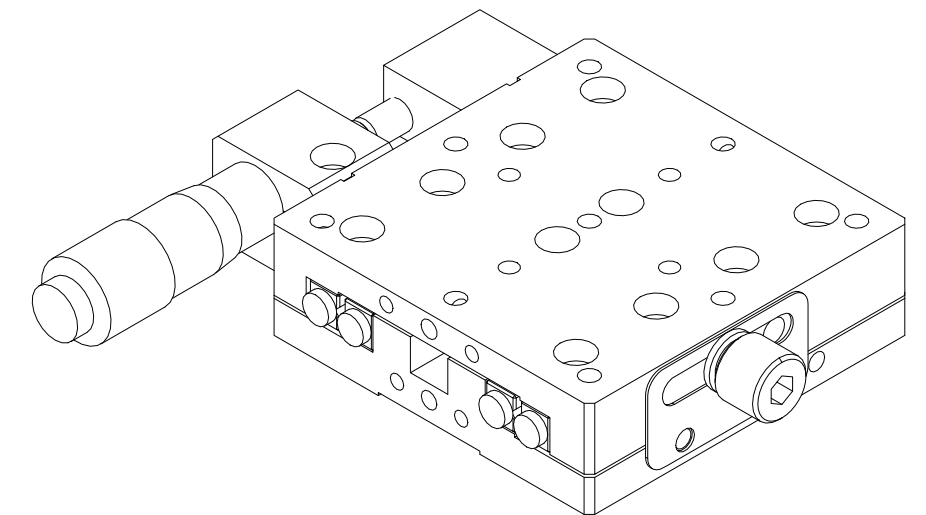
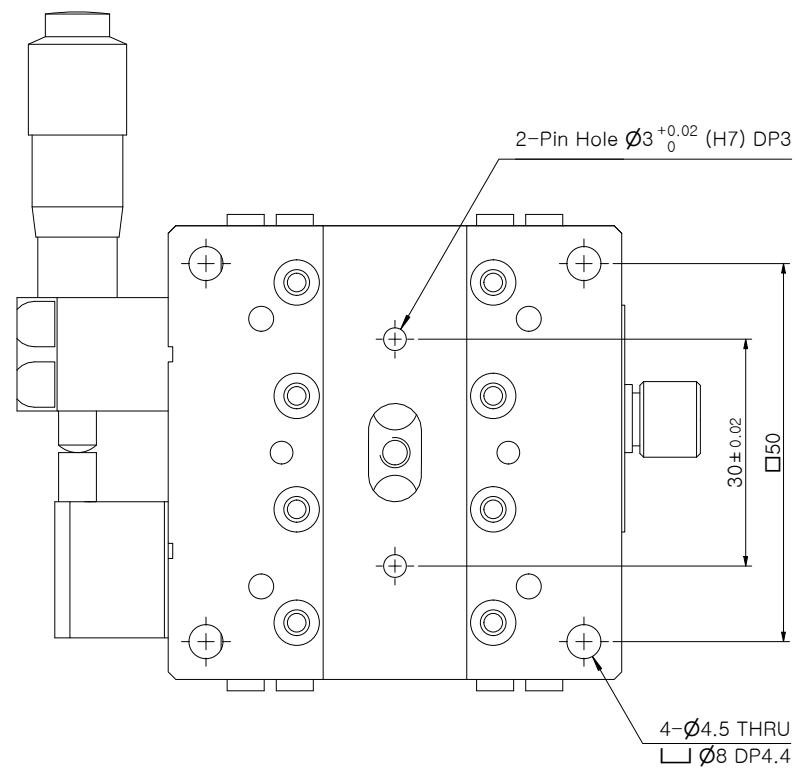
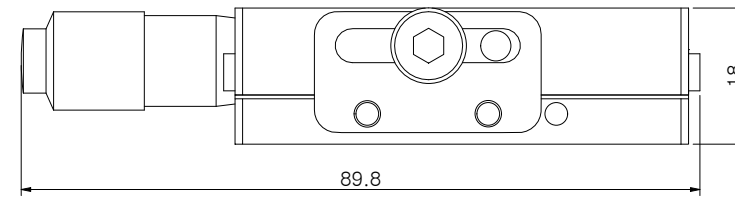
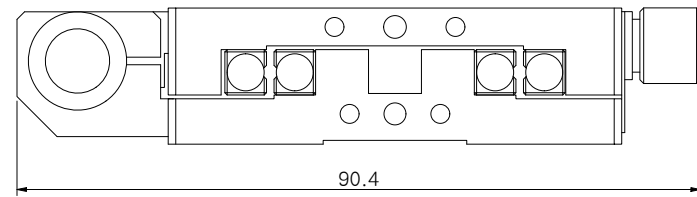
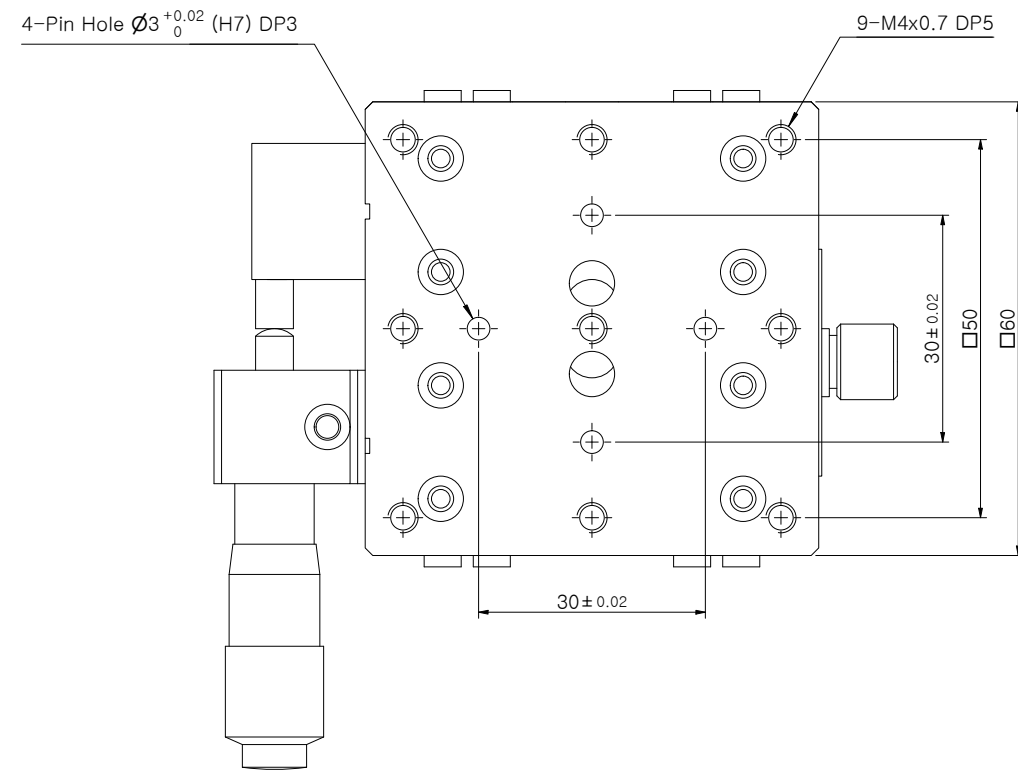

UNIT	MM	JAEWON JAEWON.CO.,LTD.	TITLE	X-60-AMC-L

SPECIFICATION

Axis	X	-
Table size	60*60	[mm]
Travel Range	± 6.5	[mm]
Mechanical Type	Micrometer Head	-
Resolution	0.01	[mm]
Guide Mechanism	Cross Roller Guide	-
Parallelism	0.03	[mm]
Running Parallelism	0.02	[mm]
Straightness	0.008	[mm]
Materials / Finish	Aluminium / Black Ano	-
Load Capacity	5	[kgf]
Product Weight	0.3	[kg]

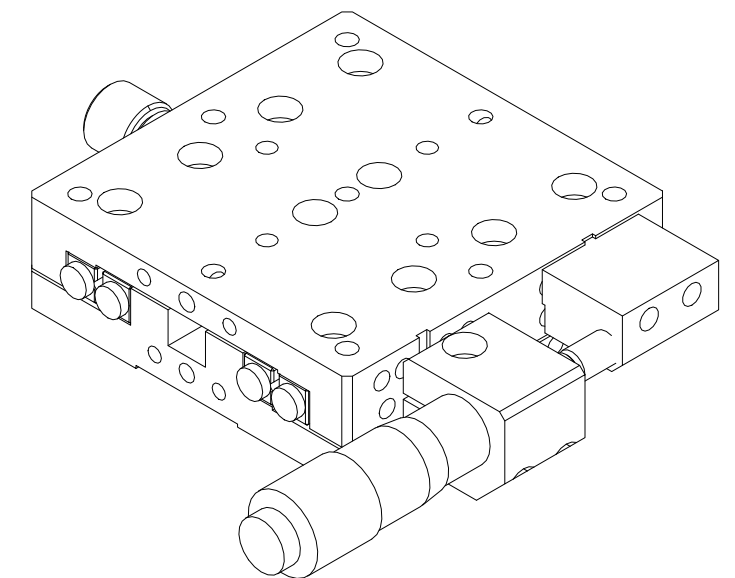
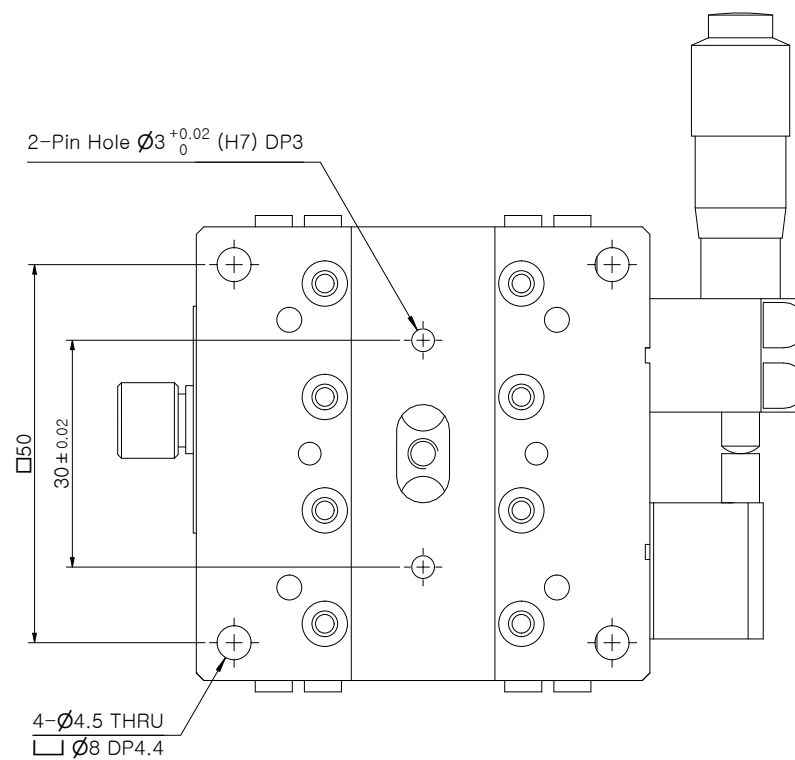
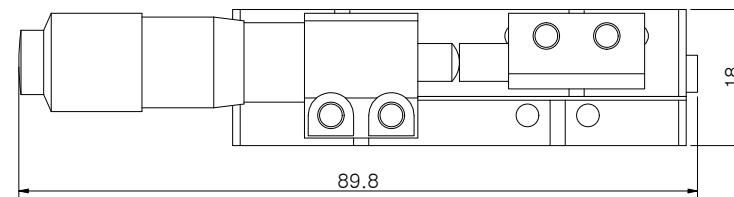
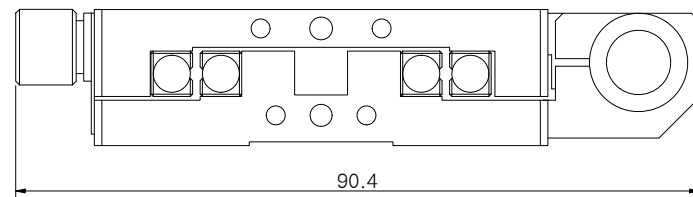
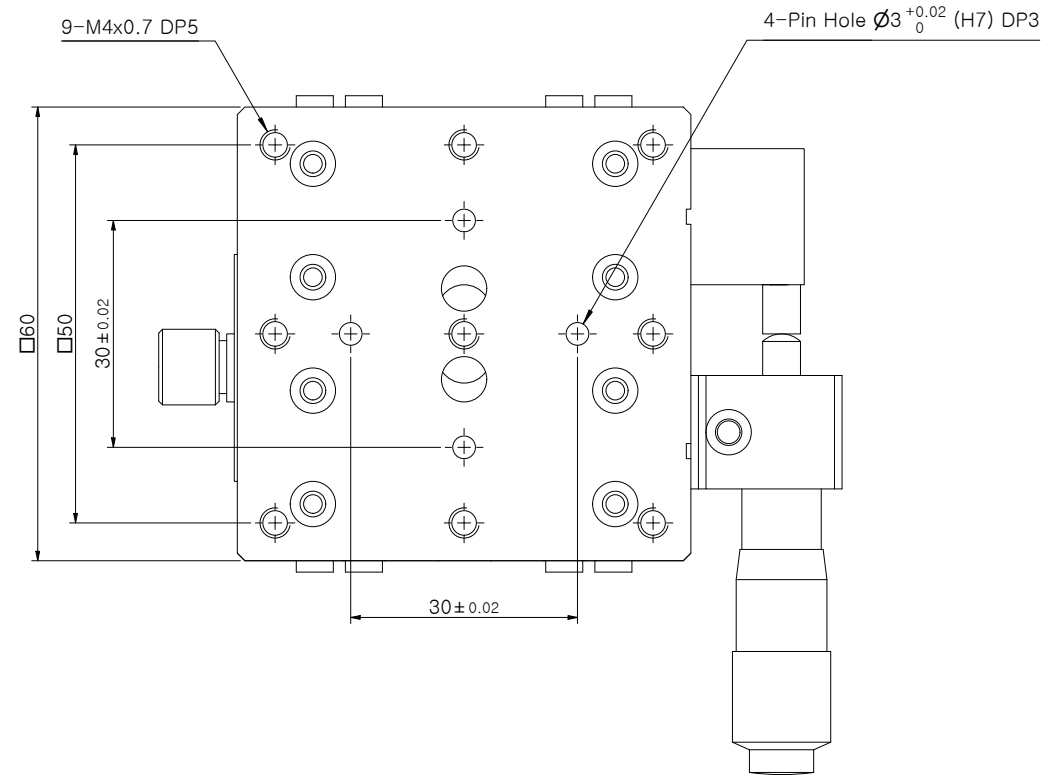

UNIT	MM	 JAEWON JAEWON.CO.,LTD.	TITLE	X-60-AMC-R
				

SPECIFICATION

Axis	X	-
Table size	60*60	[mm]
Travel Range	± 6.5	[mm]
Mechanical Type	Micrometer Head	-
Resolution	0.01	[mm]
Guide Mechanism	Cross Roller Guide	-
Parallelism	0.03	[mm]
Running Parallelism	0.02	[mm]
Straightness	0.008	[mm]
Materials / Finish	Aluminium / Black Ano	-
Load Capacity	5	[kgf]
Product Weight	0.3	[kg]

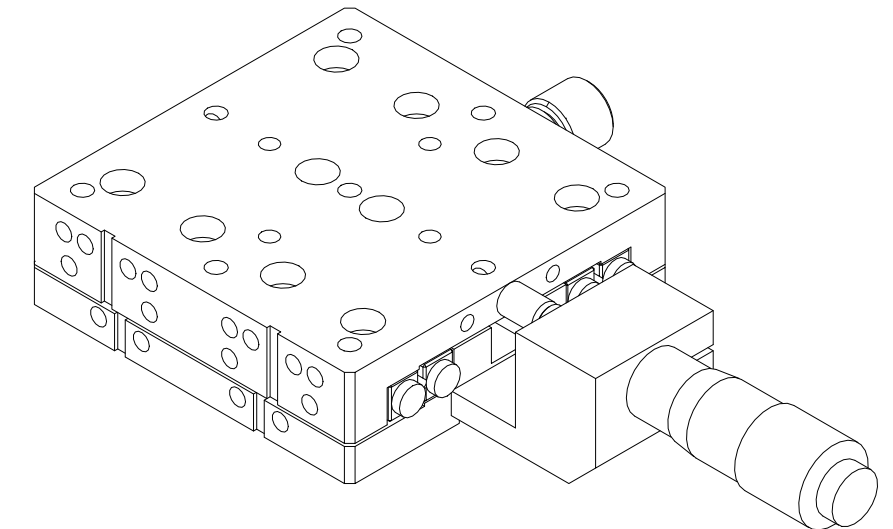
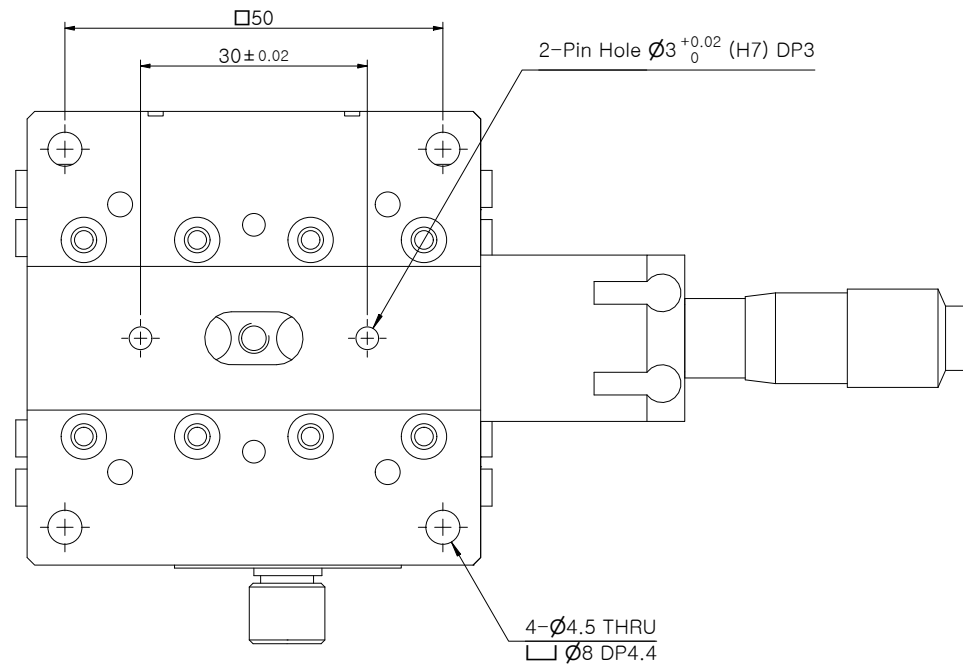
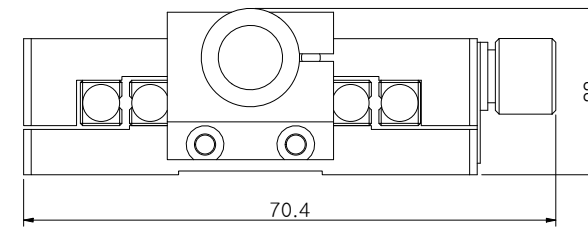
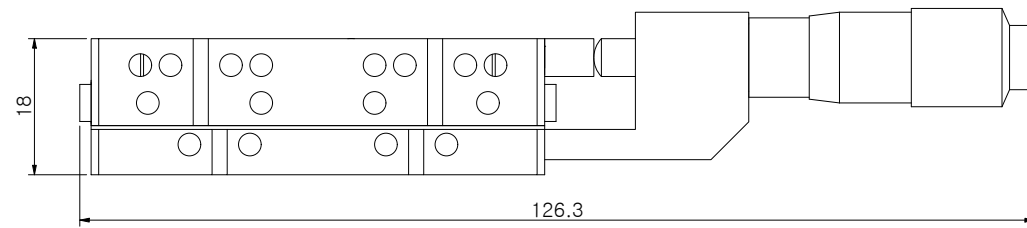
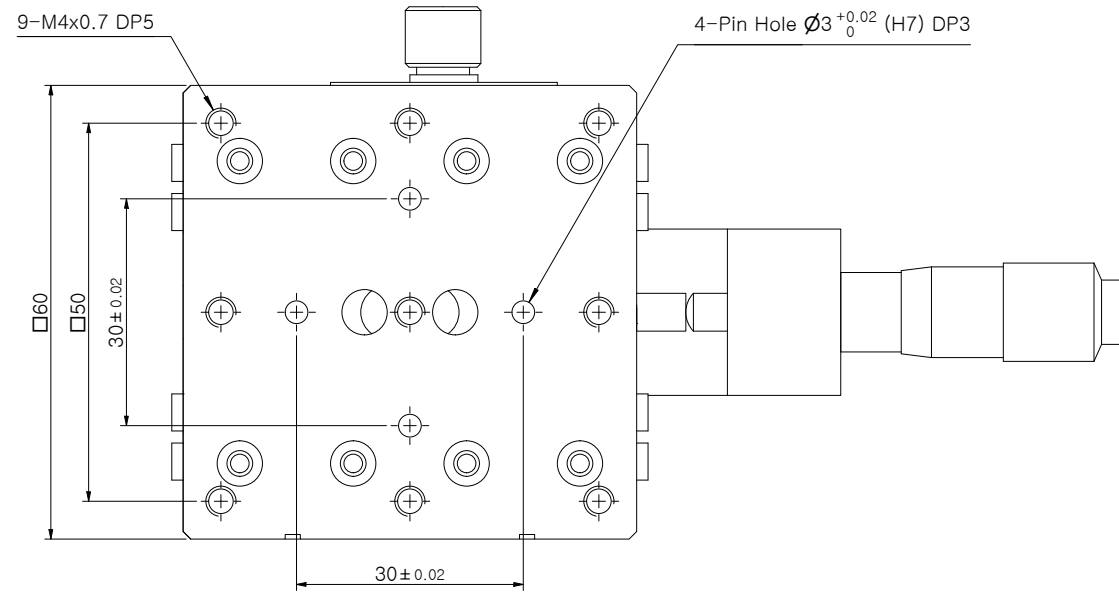

UNIT	MM	 JAEWON JAEWON.CO.,LTD.	TITLE	X-60-AMC-C
 				