

SPECIFICATION

Axis	X	-
Table size	80*80	[mm]
Travel Range	± 12.5	[mm]
Mechanical Type	Micrometer Head	-
Resolution	0.01	[mm]
Guide Mechanism	Cross Roller Guide	-
Parallelism	0.03	[mm]
Running Parallelism	0.015	[mm]
Straightness	0.005	[mm]
Materials / Finish	Aluminium / Black Ano	-
Load Capacity	10	[kgf]
Product Weight	0.4	[kg]

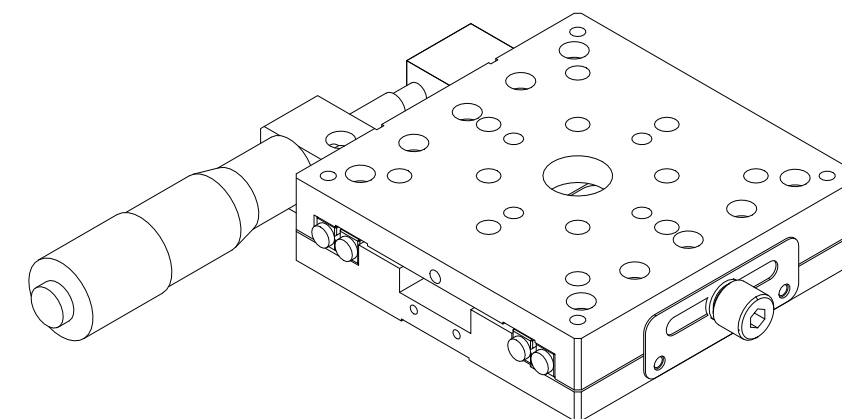

UNIT	MM		JAEWON JAEWON.CO.,LTD.	TITLE	X-80-AMC-L

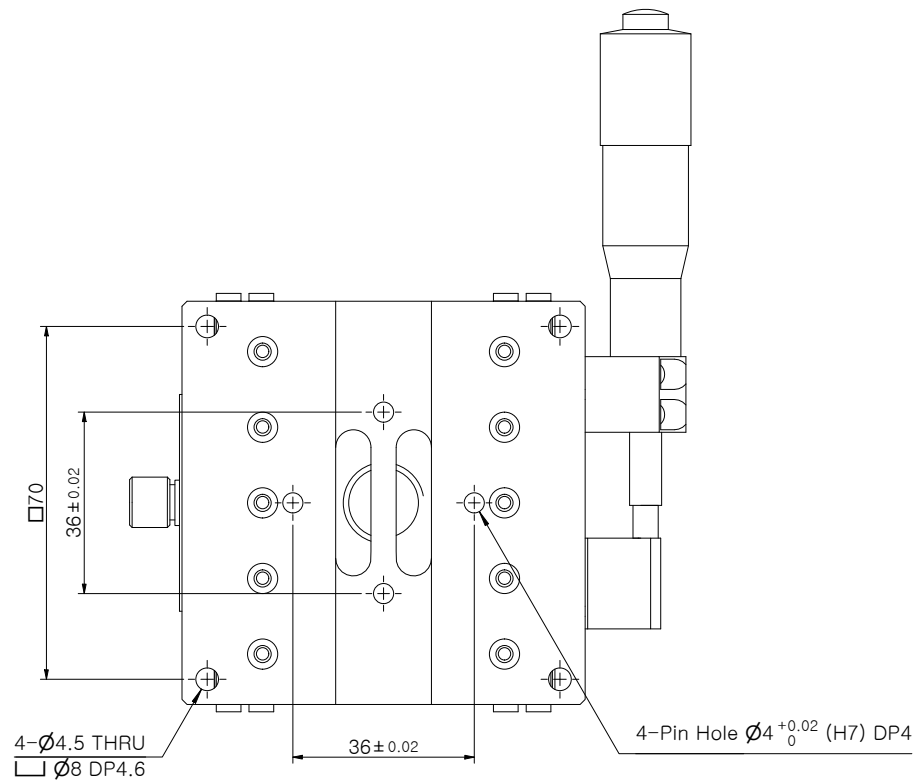
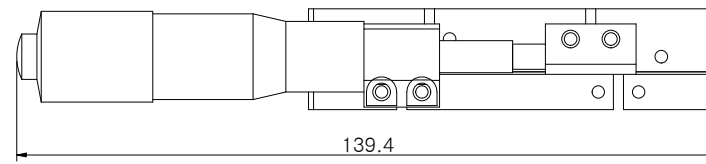
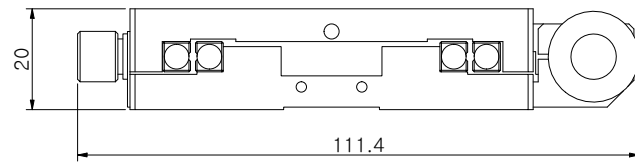
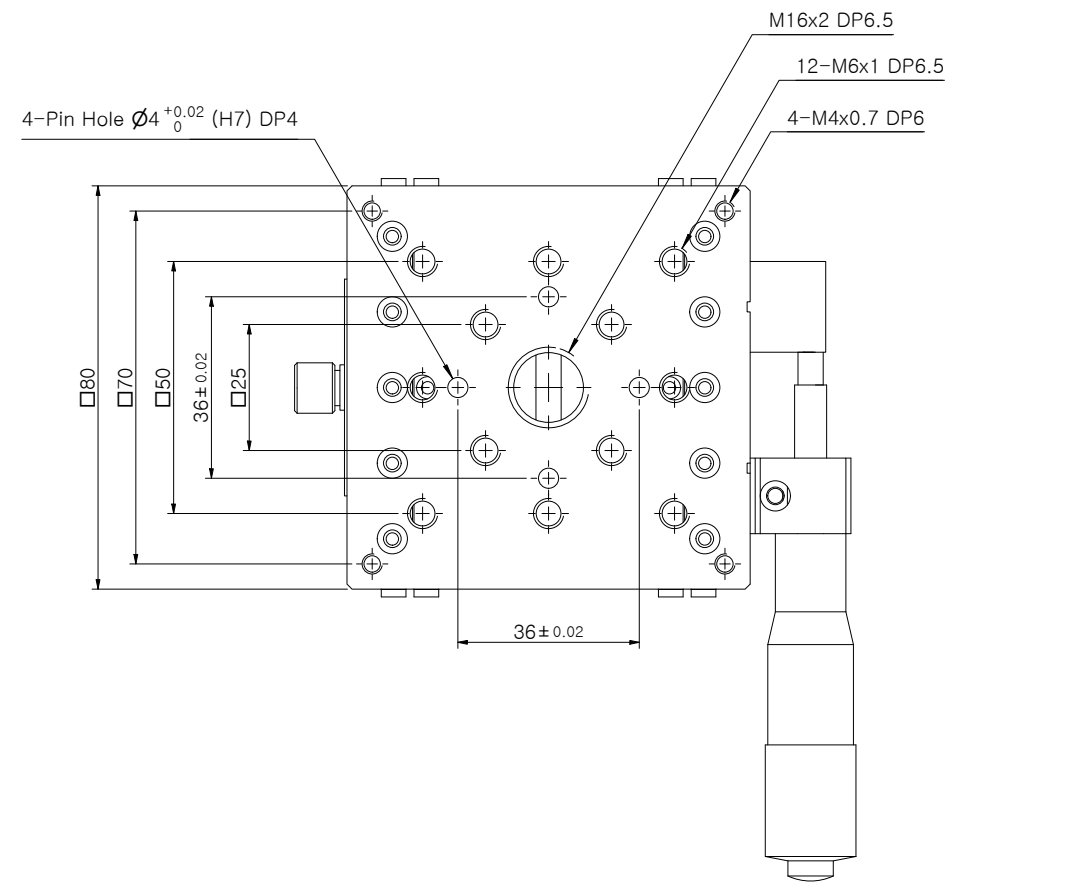

SPECIFICATION

Axis	X	-
Table size	80*80	[mm]
Travel Range	± 12.5	[mm]
Mechanical Type	Micrometer Head	-
Resolution	0.01	[mm]
Guide Mechanism	Cross Roller Guide	-
Parallelism	0.03	[mm]
Running Parallelism	0.015	[mm]
Straightness	0.005	[mm]
Materials / Finish	Aluminium / Black Ano	-
Load Capacity	10	[kgf]
Product Weight	0.4	[kg]

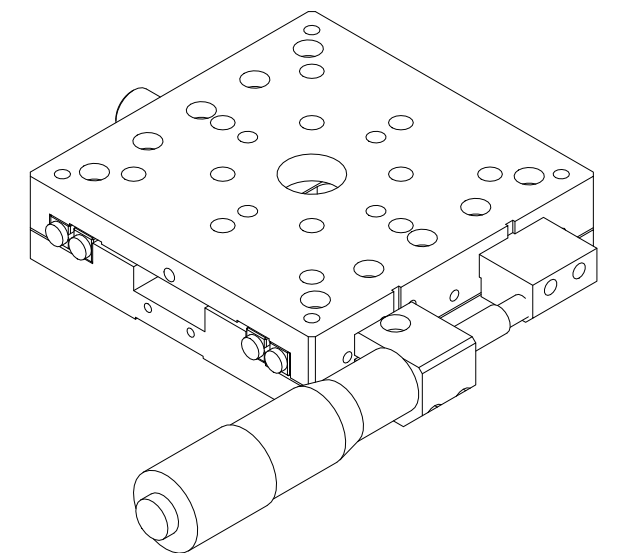

UNIT	MM	 JAEWON JAEWON.CO.,LTD.	TITLE	X-80-AMC-R
				

SPECIFICATION

Axis	X	-
Table size	80*80	[mm]
Travel Range	± 12.5	[mm]
Mechanical Type	Micrometer Head	-
Resolution	0.01	[mm]
Guide Mechanism	Cross Roller Guide	-
Parallelism	0.03	[mm]
Running Parallelism	0.015	[mm]
Straightness	0.005	[mm]
Materials / Finish	Aluminium / Black Ano	-
Load Capacity	10	[kgf]
Product Weight	0.4	[kg]

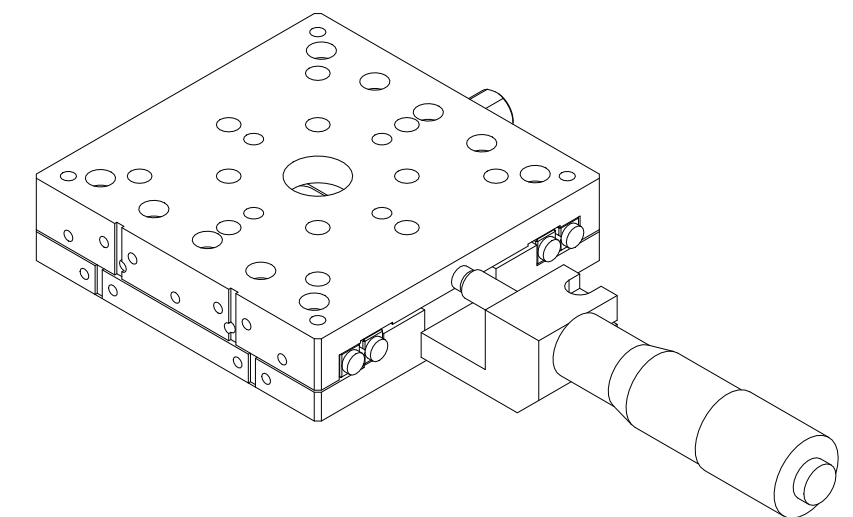
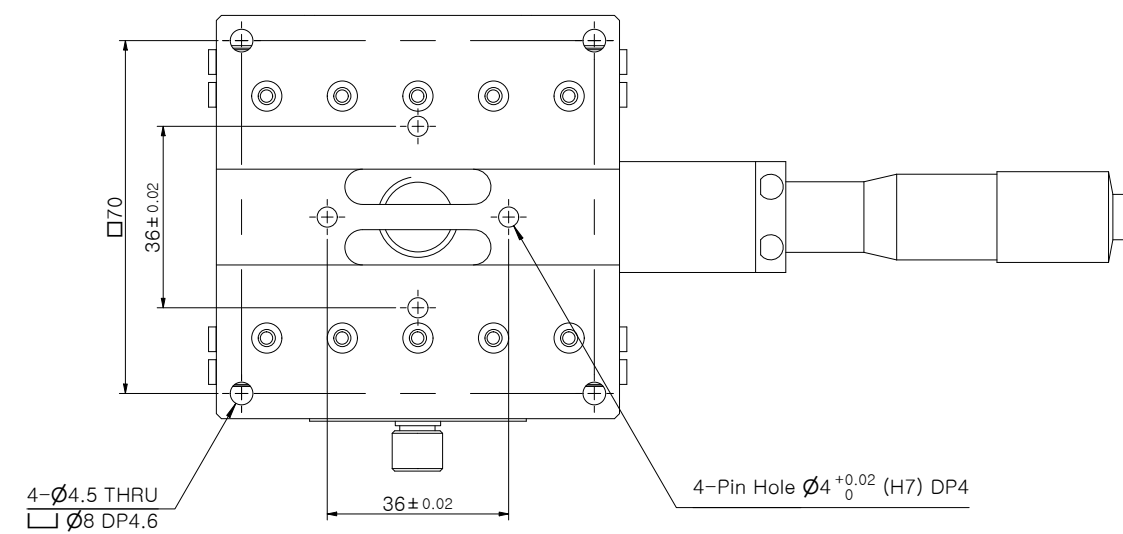
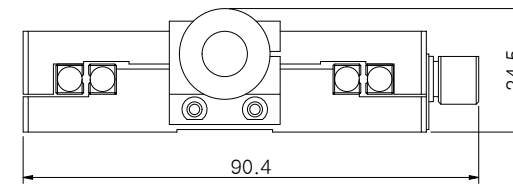
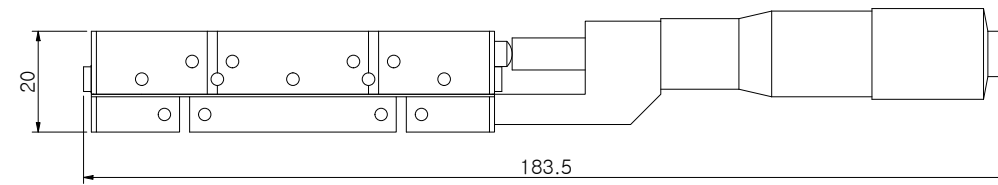
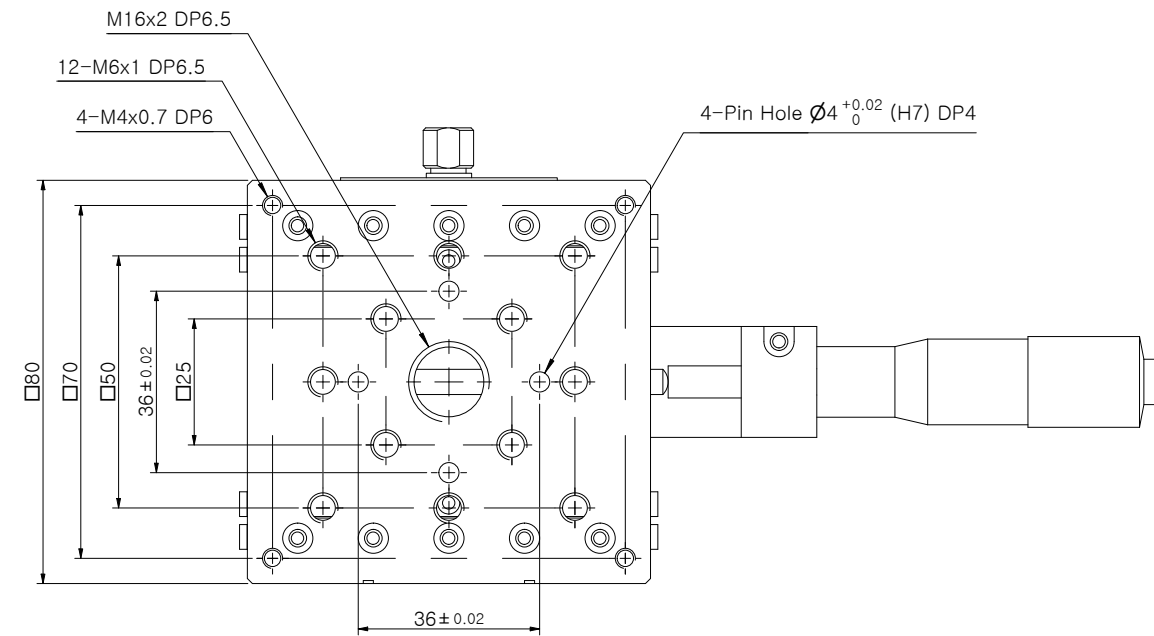

UNIT	MM	 JAEWON JAEWON.CO.,LTD.	TITLE	X-80-AMC-C
				